

## Universal Industrial Pressure Sensor



### Features

- ➔ Available with Built in Electronic
- ➔ Large choice of connectors & threads
- ➔ All Stainless steel
- ➔ Large Bandwidth

### Applications

- ➔ Railway
- ➔ Test benches
- ➔ Process
- ➔ Automation & Robotics

The PST220 series is designed for absolute or gage pressure measurements from 50mbar up to 600bar. With all stainless steel wetted parts, it is compatible with most fluids used in the industry including corrosive ones. Manufactured with proven components ensuring accuracy and reliability, the PST220 is compatible with most application thanks to a large choice of mechanical and electrical connections.

## Technical specifications

Pressure ranges (FS)	<p>±50mbar ; ±100mbar ; ±250mbar ; ±500mbar ;</p> <p>100mbar ; 250mbar ; 500mbar ;</p> <p>±1bar ; -1/+2bar ; -1/+3bar ; -1/+5bar ;</p> <p>1bar ; 2bar ; 3bar ; 5bar ; 10bar ; 20bar ; 40bar ; 100bar ; 250bar ; 400bar ; 600bar ;</p> <p>±1PSI ; ±1.5PSI ; ±3.5PSI ; ±7PSI ; ±14.5PSI ; -14.5/+30PSI ; -14.5/+40PSI ; -14.5/+70PSI ;</p> <p>1.5PSI ; 8000PSI ; 3PSI ; 5PSI ; 10PSI ; 15PSI ; 30PSI ; 40PSI ; 70PSI ; 150PSI ; 300PSI ;</p> <p>500PSI ; 1500PSI ; 3000PSI ; 5000PSI</p>
Type	Absolute ; Gage
Type (for ranges > 40 bar)	Sealed Gage
Safe overload	<p>150% FS</p> <p>Option : Special overload</p>
Burst pressure	300% FS
Power supply	15 to 30Vdc
Consumption	< 10mA
Insulation	> 1000 MOhms under 50Vdc at ambient temperature

## Technical Specifications

Output at -100%FS (only for $\pm$ range)	0Vdc
Output at 0%FS (except ranges $\pm$ )	0Vdc
Output at 100%FS	10Vdc
Zero and sensitivity settings tolerances	$\pm 50\text{mV}$
Non linearity and hysteresis combined	$\pm 0.25\%$ FS
Non repeatability	$\pm 0.02\%$ FS typ.
Signal bandwidth	1000Hz @ -3dB
Compensated temperature range	0 to +60°C Option : -25 to +85°C ; -25 to +125°C (Except M12, 723 Receptacles and PVC Cable)
Operating temperature range	-25 to +125°C (-25 to +90°C with M12, 723 Receptacles and PVC Cable)
Combined thermal zero & sensitivity shifts	$\pm 0.02\%$ FS/°C
Constant acceleration in linear vibrations	$\pm 0.02\%$ FS/g (frequency 20-2000Hz, 50g max.)
Mechanical shock	100g $\frac{1}{2}$ sinus 1ms
Electrical protection	Protected against polarity inversion
EMC protection	Compliant to EN61000
Electrical connection	DIN 43650 Receptacle - 4 pins Option : Miniature DIN 43650 mPm Receptacle - 4 pins ; Receptacle M12 - 4 pins ; Hermetic MIL-C-26482 - 6 pins Receptacle ; AWG26, Viton Jacketed Shielded Cable $\varnothing 3\text{mm}$ , 4 wires ; AWG24 double Shield PVC Cable, 4 wires ; Hermetic M12 4 pins Receptacle ; Binder 723 Receptacle, 5 pins
Mechanical connection	1/4 Gaz A male ; 1/4 NPT male Option : 1/2 Gaz A male (Gauge) ; 1/4 Gaz female ; 7/16-20 UNJF-3A male - MS33656-4 ; M10x1-4h male with 80° internal cone ; M10x1-4h male 120° cone ; M14x1.5-4h male
Material(s) of wetted parts	Stainless Steel 316L ; Stainless Steel 17-4PH ; Stainless steel 15-5PH
Weight	< 100g without cable
Enclosure protection	IP65 for absolute & sealed gage version

## Codification

Universal Industrial Pressure Sensor	PST22	6	S	1bar	A	01	01	A	1	1	L
Output Signal											
0-10Vdc		6									
Material											
Stainless Steels			S								
Range											
Example				1bar							
Type											
Absolute					A						
Gage					G						
Sealed Gage					SG						
Mechanical connection											
M14x1.5-4h male						01					
1/2 Gaz A male (Gauge)						06					
1/4 Gaz A male						07					
1/4 Gaz female						08					
7/16-20 UNJF-3A male - MS33656-4						10					
1/4 NPT male						13					
M10x1-4h male with 80° internal cone						19					
M10x1-4h male 120° cone						21					
Electrical connection											
DIN 43650 Receptacle - 4 pins							01				
Miniature DIN 43650 mPm Receptacle - 4 pins							02				
Hermetic MIL-C-26482 - 6 pins Receptacle							03				
Receptacle M12 - 4 pins							07				
AWG26, Viton Jacketed Shielded Cable Ø3mm, 4 wires							08/1m				
AWG24 double Shield PVC Cable, 4 wires							10/1m				
Hermetic M12 4 pins Receptacle							15				
Binder 723 Receptacle, 5 pins							23				
Compensated temperature range											
0 to +60°C								A			
-25 to +85°C								B			
-25 to +125°C (Except M12, 723 Receptacles and PVC Cable)								C			
Non linearity and hysteresis combined											
±0.25% FS									1		
Combined thermal zero & sensitivity shifts											
±0.02% FS/°C										1	
Options											
Special overload											L

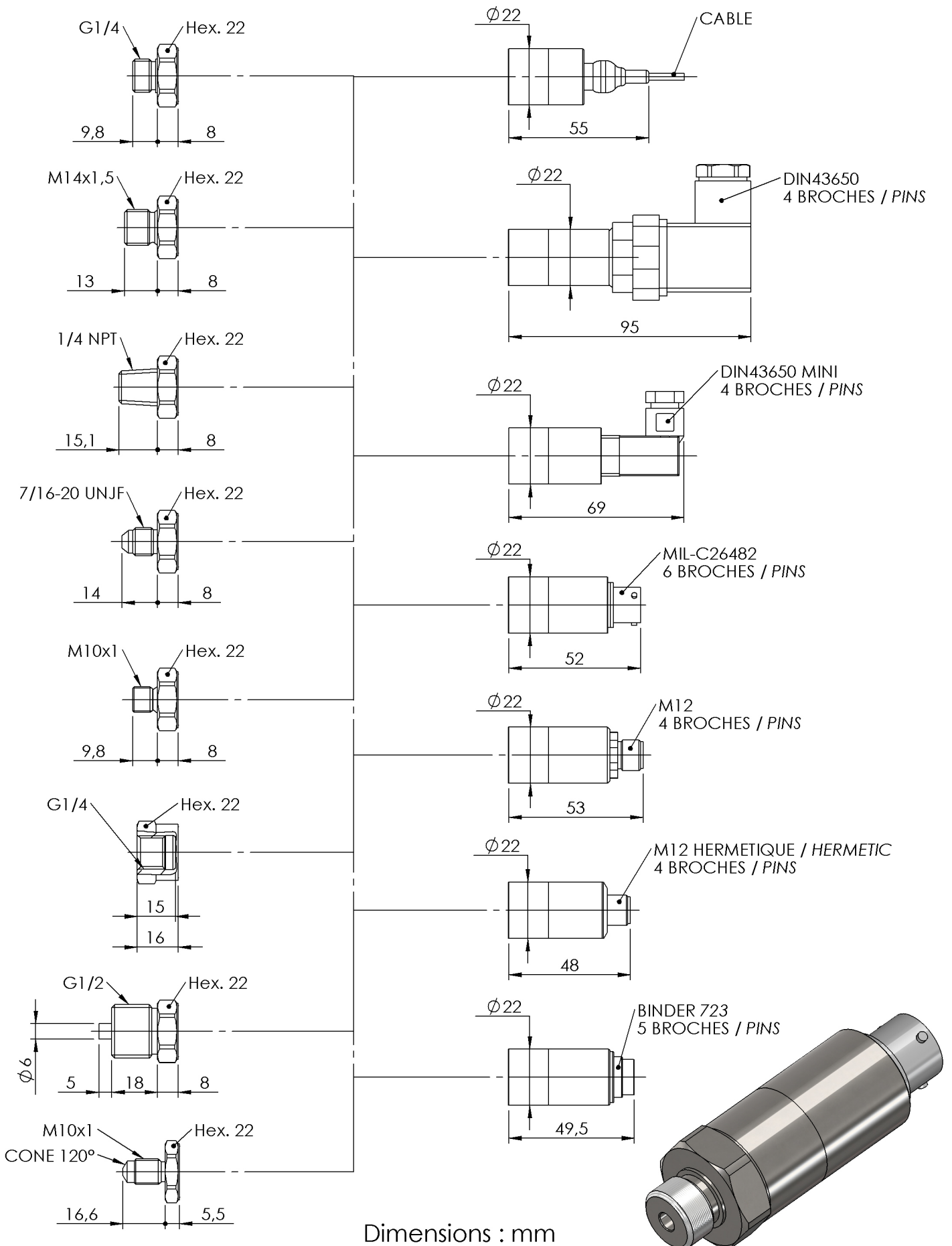

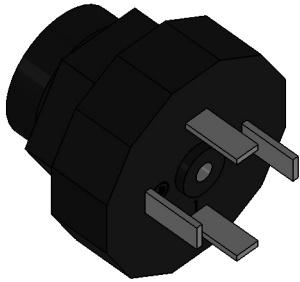

**DIN 43650 - 4 PINS**

VOLTAGE OUTPUT	PIN
+ EXCITATION	PIN 1
+ SIGNAL	PIN 2
0 VOLT	PIN 3
SENSOR HOUSING	PIN T

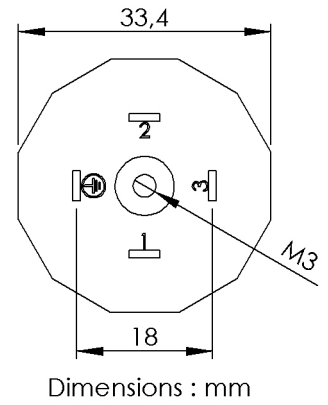

**MIL-C26482 - 6 PINS**

VOLTAGE OUTPUT	PIN
+ EXCITATION	PIN A
+ SIGNAL	PIN B
0 VOLT	PIN C
0 VOLT	PIN D
SENSOR HOUSING	PINS E & F

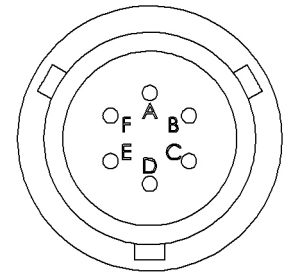

**#26 AWG, 4 CONDUCTOR SHIELDED VITON CABLE**

VOLTAGE OUTPUT	CONDUCTOR
+ EXCITATION	RED
+ SIGNAL	GREEN / YELLOW
NC	WHITE
0 VOLT	BLUE / BLACK
SENSOR HOUSING	SHIELD

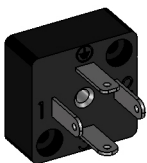
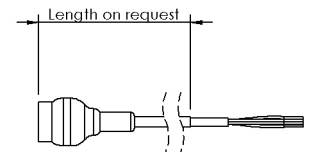

**DIN MINIATURE 43650 - 4 PINS**

VOLTAGE OUTPUT	PIN
+ EXCITATION	PIN 1
+ SIGNAL	PIN 2
0 VOLT	PIN 3
SENSOR HOUSING	PIN T

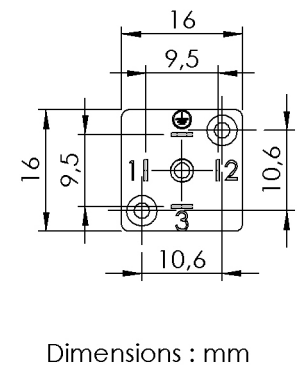

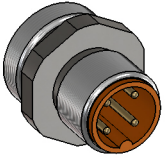

<b>M12 - 4 PINS</b>	
<b>VOLTAGE OUTPUT</b>	<b>PIN</b>
+ EXCITATION	PIN 1
+ SIGNAL	PIN 4
NC	PIN 2
0 VOLT	PIN 3
SENSOR HOUSING	CONNECTOR HOUSING

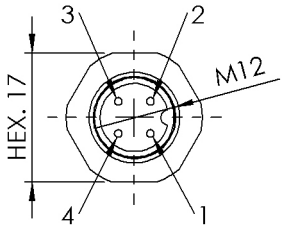

Dimensions : mm

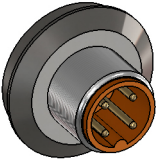

<b>HERMETIC M12 - 4 PINS</b>	
<b>VOLTAGE OUTPUT</b>	<b>PIN</b>
+ EXCITATION	PIN 1
+ SIGNAL	PIN 4
NC	PIN 2
0 VOLT	PIN 3
SENSOR HOUSING	CONNECTOR HOUSING

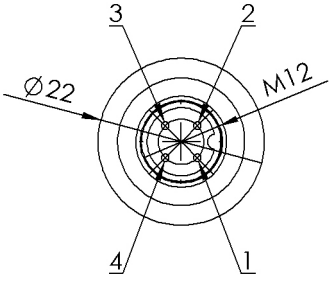

Dimensions : mm



<b>BINDER 723 - 5 PINS</b>	
<b>VOLTAGE OUTPUT</b>	<b>PIN</b>
+ EXCITATION	PIN 3
+ SIGNAL	PIN 2
NC	PIN 4
0 VOLT	PIN 1
NC	PIN 5
SENSOR HOUSING	CONNECTOR HOUSING

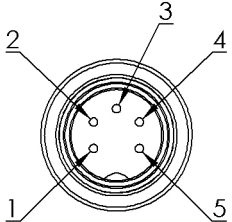

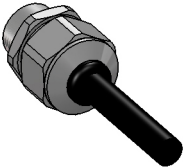

<b>#24 AWG, 4 CONDUCTOR, DOUBLE SHIELD PVC CABLE</b>	
<b>VOLTAGE OUTPUT</b>	<b>CONDUCTOR</b>
+ EXCITATION	RED
+ SIGNAL	GREEN
0 VOLT	WHITE
NC	BLACK
SENSOR HOUSING	SHIELD

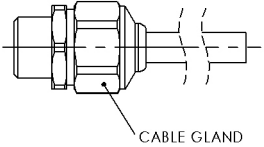

CABLE GLAND



E.F.E.

L'ESSOR FRANCAIS ELECTRONIQUE

16 Rue Porte a Bateaux - 27540 Ivry-la-Bataille - FRANCE

Tel : 33 (0)2 32 22 35 05 - Fax : 33 (0)2 32 36 93 08

[www.efe-sensor.com](http://www.efe-sensor.com) - [infos@efe-sensor.com](mailto:infos@efe-sensor.com)

Agent :

Questi prodotti sono distribuiti e supportati in Italia da:



Instrumentation Devices Srl

Via Acquanera 29 - 22100 COMO (Italy)

ph +39 031 525 391- fax +39 031 507 984

[info@instrumentation.it](mailto:info@instrumentation.it) - [www.instrumentation.it](http://www.instrumentation.it)